

# GUIDA ALLA SCELTA RAPIDA

## QUICK-REFERENCE GUIDE



TEETUBE / MINI-TEETUBE		Soluzioni protette di connessione lineare fissa <i>Protected connecting solutions of the linear type</i>		Pag. 21
		IP68 2 bar/5bar	2 poles 3 poles 5 poles 6 poles 2+2 poles 3+3 poles	
TEEDRUM		Soluzioni compatte di connessione circolare a bussola <i>Compact round terminal blocks metal inserts</i>		Pag. 45
		IP00 IP20	2 poles 3 poles 5 poles 6 poles 2+2 poles 3+3 poles	
TEEBOX		Soluzioni di connessione con contenitori protetti <i>Connecting solutions with protected boxes</i>		Pag. 55
		IP20 IP44 IP54 IP65 IP66 IP67 IP68 5 mt	Dipende dalla tipologia di connessione inserita  <i>Depending on connection type inserted</i>	
TEEBOX - Distributori di corrente		Distributori di corrente protetti <i>Protected current distributors</i>		Pag. 84
		IP20 IP40 IP54 IP65 IP66 IP68 5 mt	2 poles 3 poles 5 poles 6 poles	
TEEBLOCK		Soluzioni compatte di connessione lineare a bussola <i>Compact linear terminal blocks metal inserts</i>		Pag. 103
			2 poles 3 poles 5 poles 2+2 poles 3+3 poles	
TEEPLUG / MINI-TEEPLUG		Soluzioni protette di connessione presa-spina <i>Protected plug-socket connecting solutions</i>		Pag. 115
		IP20 IP40 IP54 IP65 IP66 IP68 5 mt	2 poles 3 poles 5 poles 6 poles	
TEEBOND		Soluzioni di passacavi - fissacavi ad aggancio rapido <i>Quick locking cable clamps</i>		Pag. 157
TEEGLAND		Soluzioni di pressacavi innovativi ad elevato grado di protezione <i>High protection innovative cable glands</i>		Pag. 167
		IP68 5bar		



# GUIDA ALLA CONSULTAZIONE DEL CATALOGO

## HOW TO READ THE CATALOGUE

**GRADI DI PROTEZIONE (vedi pag. 17)**  
**DEGREES OF PROTECTION (see page 17)**

**DATI DIMENSIONALI**  
**DIMENSIONAL DATA**

**CODICE DEL PROGETTO**  
**PROJECT CODE**

**TH211**  
**IP54**  
**IP65**

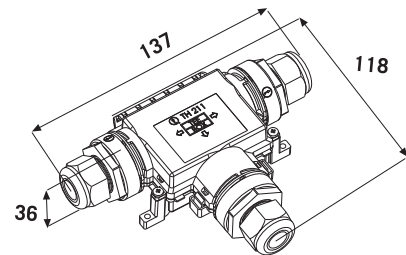

Dimensioni interne utili 57,5x44,5x26

Internal useful dimensions: 57,5x44,5x26

Scatola di protezione ad elevato grado IP per morsettiere speciali Techno, morsettiere standard, circuiti stampati, trasformatori, ecc...

An high IP rated multi-way connector box to be used with Techno terminal blocks, standard terminal blocks, printed circuits, transformers, etc..

**DATI TECNICI**  
**TECHNICAL DATA**

- Diametro cavi
- Caratteristiche elettriche di funzionamento
- Cable sections
- Electrical characteristics

Dati tecnici - Technical data

Min-Max  $\varnothing$  cavo-cable  $\oplus \ominus$  5±17mm

Vedi retro per scelta accessori -gommini dadi, morsettiere per personalizzare il vostro prodotto

See reverse for choice of other accessories-rubber seals, nuts, terminal blocks to personalise your item

Materie prime - Raw materials

Materia plastica - Plastics

PA66 UL94 V2 GWT 850°C

■ Nero - Black  
 □ Grigio - Grey  
 RAL 7035

-20°C  
 +125°C

Gomme - Rubbers

TPE-V- SILICONE- SEBS

Vite 3 x 12 INOX  
 Screw 3 x 12 STAINLESS STEEL

**MATERIE PRIME**  
**RAW MATERIALS**

78

**NORME DI RIFERIMENTO E MARCHI DI APPROVAZIONE**  
**STANDARDS AND MARKINGS**

Norme - Standards

EN 60529:1991 + A1:2000



Codice - Part number

**T H A . 2 1 1 . X X X**



**THA.211.A1A** Nero - Black } IP65  
**THA.211.A2A** Grigio - Grey }  
**THA.211.A1B** Nero - Black } IP54  
**THA.211.A2B** Grigio - Grey }



**THA.211.B1A** Nero - Black } IP65  
**THA.211.B2A** Grigio - Grey }  
**THA.211.B1B** Nero - Black } IP54  
**THA.211.B2B** Grigio - Grey }



**THA.211.C1A** Nero - Black } IP65  
**THA.211.C2A** Grigio - Grey }  
**THA.211.C1B** Nero - Black } IP54  
**THA.211.C2B** Grigio - Grey }



**THA.211.D1A** Nero - Black } IP65  
**THA.211.D2A** Grigio - Grey }  
**THA.211.D1B** Nero - Black } IP54  
**THA.211.D2B** Grigio - Grey }

Eventuali modifiche e migliorie sui dati tecnici o sul prodotto potranno essere effettuate senza preavviso.  
 All technical data or other eventual product modifications and improvements can be carried out without notice

## Come ordinare i nostri prodotti - How to order our products

**Codice - Part number**

**T H A . 2 1 1 . X X X**

**TIPOLOGIA DI KIT DI FORNITURA (vedi pag. 16)**  
**TYPE OF PURCHASING KIT (see page 16)**

**CODICE DEL PROGETTO**  
**PROJECT CODE**

**CARATTERISTICHE DEL PRODOTTO**  
**PRODUCT CHARACTERISTICS**

- Polarità, colore, tipologia di connessione, etc.
- Polarity, colour, connection type, etc.

**ACCESSORI DISPONIBILI PER QUESTO PROGETTO**  
**AVAILABLE ACCESSORIES FOR THIS PROJECT**

**Accessori per il fissaggio - Fixing accessories**

Schema di fissaggio - Fixing scheme

601000500  
 Ø 2.95 x 25 mm

604000100  
 Ø 4 x 20 mm

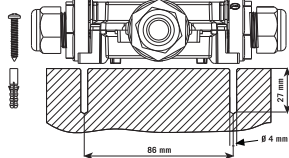

**Accessori per cavo max Ø 14 mm - Cable accessories, max Ø 14 mm**

	6DB000800	Double Yellow Seal	Ø <sub>E</sub> 15,5 - Ø <sub>I</sub> 8		Ø 5±14mm
	604001800	Yellow Seal	Ø <sub>E</sub> 15,5 - Ø <sub>I</sub> 12		Ø 9±14mm
	600012500	Yellow Seal	Ø <sub>E</sub> 15,5	2 Fori - 2 Holes	Ø 3,5
	600012600	Yellow Seal	Ø <sub>E</sub> 15,5	3 Fori - 3 Holes	Ø 3,5
	600018200	Yellow Seal	Ø <sub>E</sub> 15,5	4 Fori - 4 Holes	Ø 3,5
	600012700	Yellow Seal	Ø <sub>E</sub> 15,5	Asola - Slot	Ø 11x5,5
	600013600	Yellow Seal	Ø <sub>E</sub> 15,5	1 Foro - 1 Hole	Ø 3,5
	600013700	Yellow Seal	Ø <sub>E</sub> 15,5	Foro Cieco - Blind Hole	
	604001100	Black Seal	Ø <sub>E</sub> 15,5 - Ø <sub>I</sub> 8,5		Ø 5+9mm
	6000087LF	Riduzione Adapter	Foro - Hole Ø 9	} Per dado for nut	CH Ø 24mm
	6000156LF	Foro cieco Blind hole	Foro - Hole Ø 9		



Morsettiere Techno applicabili - vedi schede prodotto per eventuale scelta versione.  
 Applicable Techno terminal blocks - see product data sheets to choose suitable version.

THC.027.A1A



Supporto morsettiere  
Terminal block support

6000194CC

TH 26 3-5 poli / 3-5 poles



6000194CC

TH 029

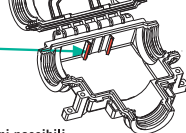

**Esempi di altre applicazioni possibili**  
**Some other possible applications**

Morsettiere, circuiti stampati e trasformatori  
 Terminal blocks, printed circuits and transformers



**Kit di fornitura non assemblato THA**  
**Unassembled kit THA**

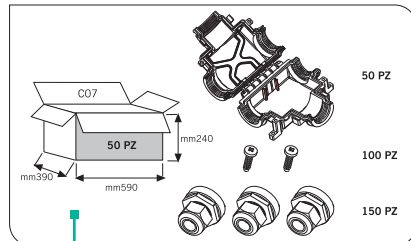

**Kit di fornitura assemblato THZ**  
**Assembled kit THZ**

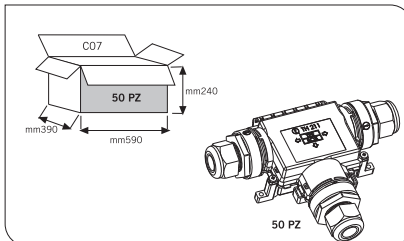

**Kit di fornitura imbustati THR**  
**Fare riferimento a catalogo THR**  
**Retail packed kit THR**  
**Please refer to THR Retail Catalogue**

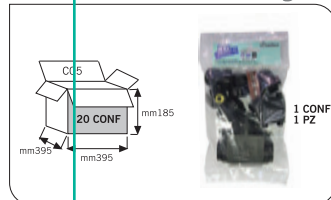

**Kit di fornitura con versionamenti e confezionamenti speciali THK**  
**Special custom packed version THK**

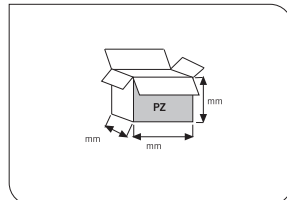

Vedi istruzioni di assemblaggio  
 Refer to user instructions



**ALTRE INFORMAZIONI**  
**ADDITIONAL INFORMATION**

- Note tecniche
- Installazione
- Integrazione con altri prodotti TEEfamily
- Etc.
- Technical information
- Installation rules
- Integration between TEEfamily products
- Etc.

79

**LOGO DELLA FAMIGLIA**  
**COLORE PER IDENTIFICAZIONE VELOCE**  
**FAMILY LOGO**  
**COLOUR TAG FOR QUICK-REFERENCE**

**TIPOLOGIA DI KIT DI FORNITURA (vedi pag. 16)**  
**TYPE OF PURCHASING KIT (see page 16)**

- Tipologia di fornitura
- Quantità per imballo
- Type of assembling
- Quantity/package type



# TIPOLOGIE DI KIT DI FORNITURA

## TYPES OF PURCHASING KIT

I prodotti TEEfamily sono venduti in tre (più una) tipologie differenti di kit di fornitura.

The TEEfamily products can be purchased in three (plus one) different types of purchasing kit as follows.



### THA / THB / THF / THH Kit di fornitura non assemblato - Unassembled kit

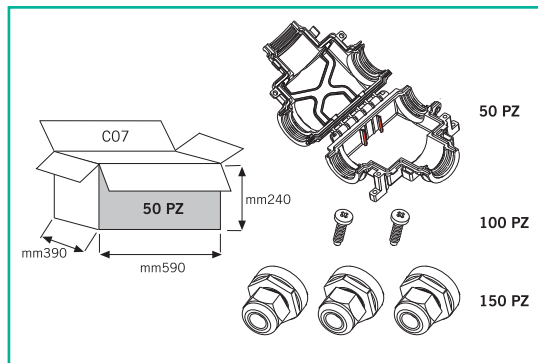

È la versione di fornitura con prodotto non assemblato. Normalmente viene acquistato dai clienti OEM i quali preferiscono avere i componenti separati per velocizzare l'assemblaggio del prodotto TEEfamily sui loro apparecchi. Questa versione consente un risparmio di tempo e di denaro non dovendo disassemblare il prodotto.

*It is the version by which the products are supplied unassembled and normally purchased by OEM customers who prefer to have the items delivered in this manner for when they connect the units to their fixtures and they save time, energy and of course money as they then do not need to disassemble to use the product.*

### THZ Kit di fornitura assemblato - Assembled kit

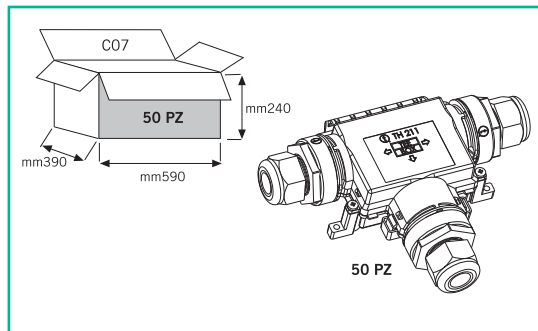

È la versione di fornitura con prodotto assemblato. Normalmente viene acquistato da alcuni clienti OEM che non necessitano di assemblare il prodotto, bensì lo vendono insieme ai loro apparecchi. Viene acquistato anche da grossisti di materiale elettrico i quali vendono a installatori e impiantisti.

*It is the version by which the products are supplied partially assembled and normally purchased by some limited OEM customers that do need to install within their own products but supply together with these products and mainly by electrical wholesalers who prefer to have the items delivered in this manner as they either sell the items to electricians, installers, etc directly or place a fully assembled item in the box with a fixture.*

### THR Kit di fornitura imbustato - Retail packed kit

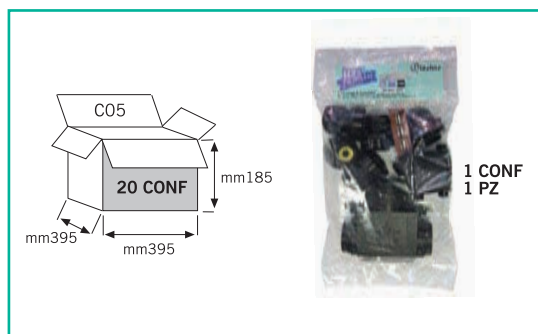

È la versione di fornitura con prodotto in parte assemblato e imbustato. Normalmente viene acquistato da grossisti e rivenditori di materiale elettrico che necessitano, per esempio, l'esposizione del prodotto sugli appositi espositori da banco.

Per maggiori dettagli, vedi catalogo rivendita (THR).

*It is the version by which the products are supplied assembled and retailed packed normally purchased by electrical wholesalers and in particular retailers who prefer to have the items delivered in this manner so as to exhibit directly on retail shelves for end customers to help themselves.*

*For further information, see the catalogue for retailers (THR).*

### THK Kit di fornitura speciale - Special custom packed kit

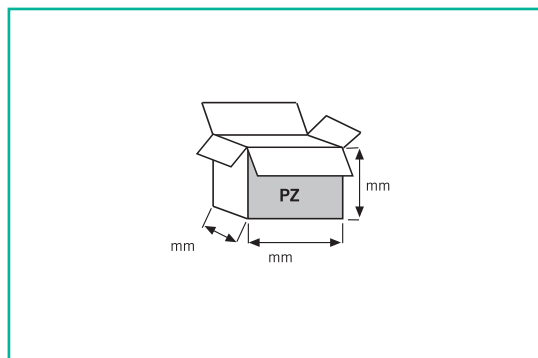

È la versione di fornitura costruita in funzione delle esigenze del cliente in termini di quantità e tipologia di accessori richiesti. Questa tipologia di kit viene raramente richiesta poiché le altre versioni coprono la quasi totalità delle richieste del mercato. Questa versione viene fornita solo per specifiche quantità che devono essere concordate con il cliente e riordinate regolarmente nel corso dell'anno.

*This version is the "plus one" mentioned above is a custom made version by which the products are supplied in function of what the specific customer requires of all the possible accessories, etc. This version is in all frankness becoming a rarer requirement as normally one of the three versions above cover all the possible needs. The THK is provided only for very specific quantities purchased continuously throughout the year. Quantities are agreed to with the customers.*

**Nota:** contattare il servizio clienti Techno per verificare la disponibilità dei codici THZ..., THR... e THK...

**Notes:** please contact our Customer Service to check the availability of products THZ..., THR... and THK...



# GRADI DI PROTEZIONE DEGLI INVOLUCRI (Codice IP)



## DEGREES OF PROTECTION PROVIDED BY ENCLOSURES (IP Code)

Esempio/Example: **IP68**

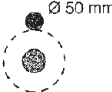
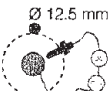
**Prima cifra** Protezione contro corpi solidi  
**First digit** Protection against solid bodies

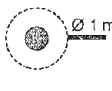
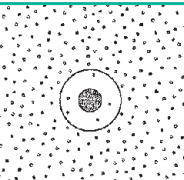
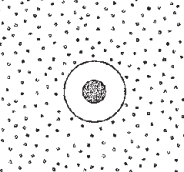
**Seconda cifra** Protezione contro liquidi  
**Second digit** Protection against liquids

<b>0</b>		Non protetto <i>Non-protected</i>
<b>1</b>		Protetto contro corpi solidi estranei di diametro ≥ 50 mm <i>Protected against solid foreign objects of 50 mm Ø and greater</i>
<b>2</b>		Protetto contro corpi solidi estranei di diametro ≥ 12,5 mm <i>Protected against solid foreign objects of 12,5 mm Ø and greater</i>
<b>3</b>		Protetto contro corpi solidi estranei di diametro ≥ 2,5 mm <i>Protected against solid foreign objects of 2,5 mm Ø and greater</i>
<b>4</b>		Protetto contro corpi solidi estranei di diametro ≥ 1,0 mm <i>Protected against solid foreign objects of 1,0 mm Ø and greater</i>
<b>5</b>		Protetto contro la polvere <i>Dust-protected</i>
<b>6</b>		Totalmente protetto contro la polvere <i>Dust-tight</i>

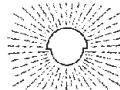
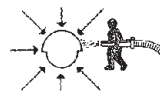
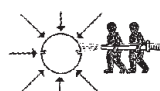
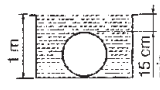
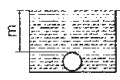
<b>0</b>		Non protetto <i>Non-protected</i>
<b>1</b>		Protetto contro la caduta verticale di gocce d'acqua <i>Protected against vertically falling water drops</i>
<b>2</b>		Protetto contro la caduta verticale di gocce d'acqua con un'inclinazione dell'involucro fino a 15° <i>Protected against vertically falling water drops when enclosure tilted up to 15°</i>
<b>3</b>		Protetto contro la pioggia <i>Protected against spraying water</i>
<b>4</b>		Protetto contro gli spruzzi d'acqua <i>Protected against splashing water</i>
<b>5</b>		Protetto contro i getti d'acqua <i>Protected against water jets</i>
<b>6</b>		Protetto contro i getti d'acqua potenti <i>Protected against powerful water jets</i>
<b>7</b>		Protetto contro gli effetti dell'immersione temporanea <i>Protected against the effects of temporary immersion in water</i>
<b>8</b>		Protetto contro gli effetti dell'immersione continua <i>Protected against the effects of continuous immersion in water</i>

Le tabelle riportate in questa pagina sono estratte dalla norma IEC EN 60529 (CEI 70-1).

The tables shown in this page are taken from IEC EN 60529 (CEI 70-1) standards.